

プラキャップ

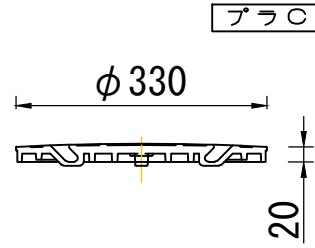

铸铁キャップ

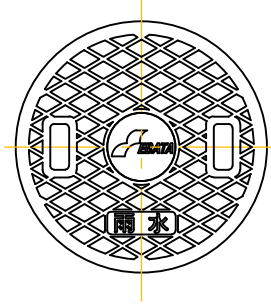
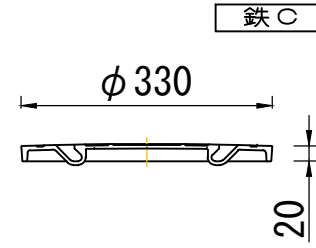
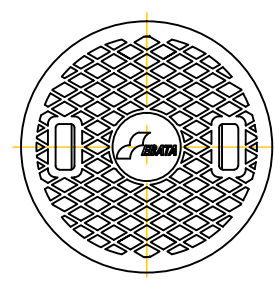

アジャスター

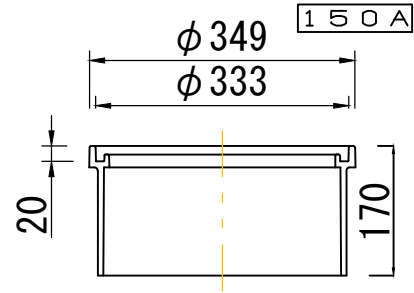
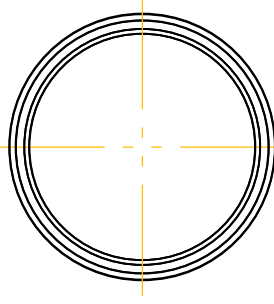

多孔ます

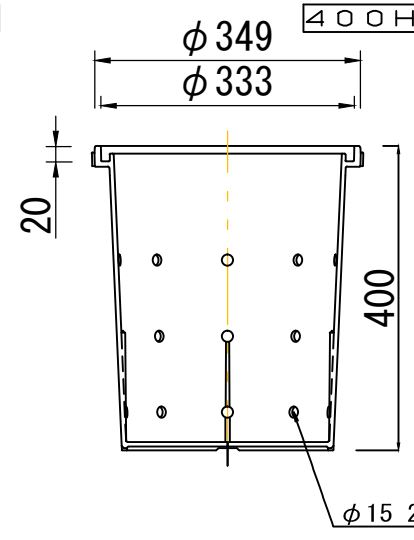
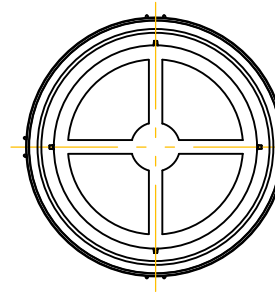

多孔ます

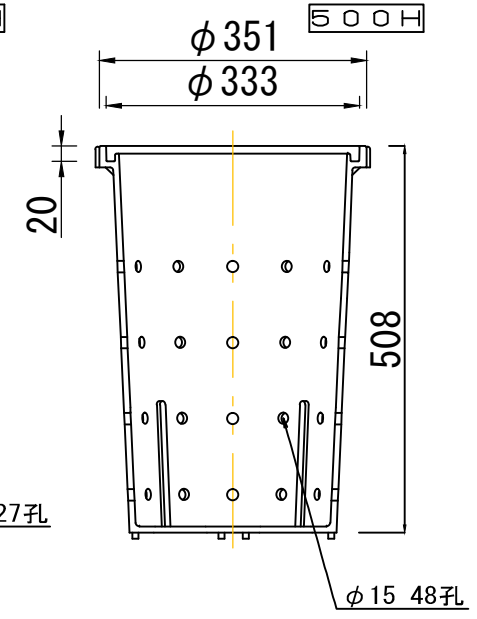
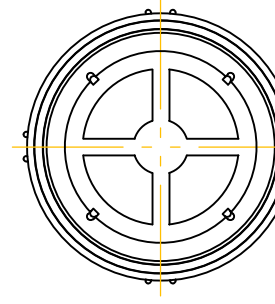

穴アキプラキャップ

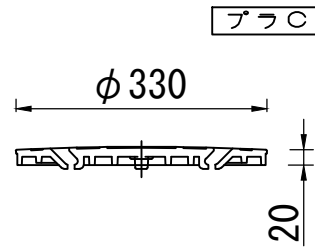
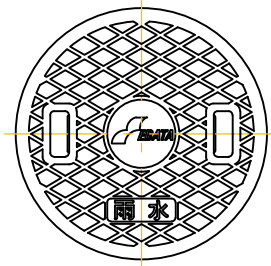

铸铁格子キャップ

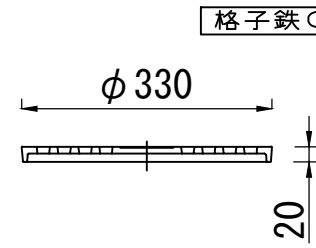
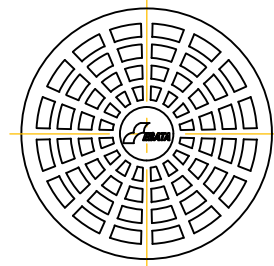

ビルマテル株式会社

工事名称

図面名称

ドレーンカバー・蓋

製図

S. Aoki

検図

Y. Hasebe

尺度

1/10(A3)

作成日

2016.04.13

図面番号

変更事項
